

LBL05IR850CI

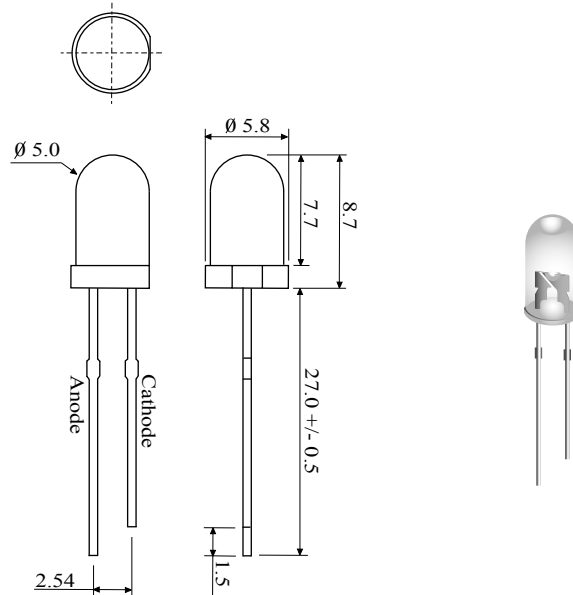

NOTE: TOLERANCE +/- 0.2mm

- * ABSOLUTE MAXIMUM RATINGS: (Ta=25°C)
- * OPERATING TEMPERATURE: -40°C TO + 80°C
- * LEAD SOLDERING :260°C FOR 5 SECONDS

PARAMETER	TEST CONDITION	Symbol	MIN.	TYP.	MAX.	UNIT
Forward Voltage	IF=20mA	VF	1.2	1.4	1.6	V
	IF=100mA		-	1.7	1.95	
Reverse Current	VR=5V	IR			10	uA
Radiant Intensity	IF=20mA	Ee	11	21	-	mW
	IF=100mA		-	85	-	
Peak Wavelength	IF=20mA	λ p		850		nm
Continuous Forward Current		IF		40		mA
Power dissipation		Pd		110		mW
Viewing Angle	Iy=20mA	2 θ 1/2		45		deg